



“Detection and elimination of Heart sound from Lung sound based on wavelet multi resolution analysis technique and linear prediction”

Mr. Sibiu Thomas, Assistant Professor, Department of Computer Science,
St. Thomas college, Ruabandha, Bhiali, Durg, Chhattisgarh, India

&

Ms. Nishi Shahnaj Haider, Assistant Professor,
Department of Applied Electronics & Instrumentation Engineering,
Bhilai Institute of Technology (BIT), Raipur, Chhattisgarh, India

Abstract—This paper presents a novel method for Heart Sound (HS) cancellation from Lung Sound (LS) records. The method uses the multiscale product of the wavelet coefficients of the original signal to detect HS segments. Once the HS segments are identified, the method removes them from the wavelet coefficients at every level and estimate the created gaps by either an autoregressive or moving average model. It is shown that if the segment to be predicted is stationary, a final record with no audible artifacts such as clicks can be reconstructed using this approach. The results were promising for HS removal from LS without hampering the main components of the LS. The results were confirmed both qualitatively by listening to the reconstructed signal and quantitatively by spectral analysis.

The aim of this proposed work is achieved by implementing a VI for Heart Sound (HS) removal from Lung Sound (LS) records using the Advanced Signal Processing Toolkit of LabVIEW 8.6. The method uses the multi-resolution analysis of the wavelet approximation coefficients of the original signal to detect HS-included segments.

Once the HS segments are identified, the method removes them from the wavelet coefficients and estimates the created gaps by using TSA ARMA modeling and prediction.

Index Terms—Virtual Instrument (VI), Multiresolution analysis (MRA), Time series analysis (TSA), Autoregressive Moving average (ARMA), Heart sound (HS), Lung sound (LS).

I. INTRODUCTION

Auscultation of the lung sound is a simple and noninvasive method to obtain some instant but useful information to detect various respiratory diseases [1]. It is defined as the act of listening for sounds within the body, mainly for ascertaining the condition of the lungs, heart and other organs [2]. Diseases such as asthma, tuberculosis can be identified with this method through the analysis of lung and tracheal sounds. However, one of the main problems in lung sound analysis is the interference of heart sounds, which is unavoidable during lung sound recording.

Wavelet transformation based denoising technique has been proposed for heart sound reduction from lung sound [1].

Research on the diagnosis of respiratory pulmonary conditions like bronchitis, sleep apnea, asthma has established the utility of the stethoscope's acoustic signal in common day to day practice. However, despite their effectiveness, these instruments only provide a limited and subjective perception of the respiratory sounds. The drawbacks of using stethoscopes and listening to the sounds using the human ear are a) their inability to provide an objective study of the respiratory sounds detected, b) their lack of sufficient sensitivity and (c) the existence of the imperfect system of nomenclature [4].

Heart sounds overlap with lung sounds such that it hampers the potential of respiratory sound analysis in terms of diagnosis of respiratory illness. The features of lung sounds may be impure by heart sounds because lung and heart sounds overlap in terms of time domain and spectral content. This paper presents a method of lung sound analysis using the advanced signal processing tools of LabVIEW 8.6. The method uses the multi-resolution analysis of the wavelet approximation coefficients of the original signal to detect HS-included segments.

HEART SOUNDS AND LUNG SOUNDS

Respiratory sounds present noninvasive measures of lung airway conditions [6]. However, features of lung sounds may be contaminated by heart sounds because lung and heart sounds overlap in terms of time domain and spectral content [7]. Heart sounds are clearly audible in lung sounds recorded on the anterior chest and may be heard to a lesser extent in lung sounds recorded over posterior lung lobes.

A. Lung Sounds

Breath sounds originate in the large airways where air velocity and turbulence induce vibrations in the airway walls. These vibrations are then transmitted through the lung tissue and thoracic wall to the surface where they may be heard readily with the aid of a stethoscope.



Lung sounds are produced by vertical and turbulent flow within lung airways during inspiration and expiration of air. Lung sounds recorded on the chest wall represent not only generated sound in lung airways but also the effects of thoracic tissues and sound sensor characteristics on sound transmitted from the lungs to a data acquisition system.

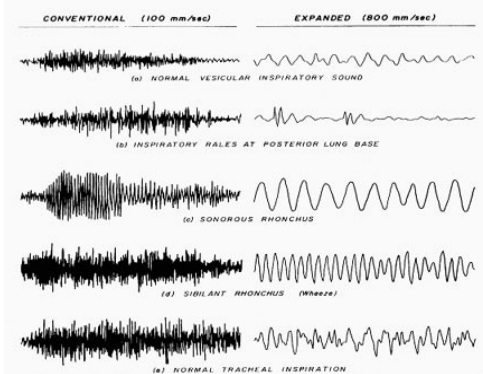

Fig 1. Amplitude-versus-time plots of typical lung sounds, showing that the expanded time scales in the right column reveal visually distinct patterns not readily seen in the plots at conventional speeds on the left.

Lung sounds exhibit a Power Spectral Density that is broadband with power decreasing as frequency increases. The logarithm of amplitude and the logarithm of frequency are approximately linearly related in healthy subjects provided that the signals do not contain adventitious sounds increases and several mathematical relations between lung sounds and airflow have been proposed. Inspiratory and expiratory lung sounds differ in amplitude and frequency.

B. Heart Sounds

Heart sounds are produced by the flow of blood into and out of the heart and by the movement of structures involved in the control of this flow [10]. The first heart sound results when blood is pumped from the heart to the rest of the body, during the latter half of the cardiac cycle, and it is comprised of sounds resulting from the rise and release of pressure within the left ventricle along with the increase in ascending aortic pressure [10]. After blood leaves the ventricles, the simultaneous closing of the semi lunar valves, which connect the ventricles with the aorta and pulmonary arteries, causes the second heart sound.



Fig 2. A schematic diagram of Human Heart sound

The electrocardiogram (ECG) represents the depolarization and repolarisation of heart muscles during each cardiac cycle. Depolarization of ventricular muscles during ventricular contraction results in three signals known as the Q, R, and S-waves of the ECG [10]. The first heart sound immediately follows the QRS complex. In health, the last 30–40% of the interval between successive R-wave peaks contains a period that is void of first and second heart sounds [7].

Characteristics of heart sound signals have been assessed in terms of both intensity and frequency. Though peak frequencies of heart sounds have been shown to be much lower than those of lung sounds [11], comparisons between lung sound recordings acquired over the anterior right upper lobe containing and excluding heart sounds show that PSD in both cases is maximal below 150 Hz.

III VI IMPLEMENTATION

LabVIEW 8.6 is a graphical system design software platform for control, test and embedded system development. Building on the inherent parallel nature of graphical programming, it delivers tools to help engineers and scientists take advantage of the benefits of multicore processors, field-programmable gate arrays (FPGAs) and wireless communication. The platform includes more than 1,200 advanced analysis functions optimized for faster math and signal processing on multicore systems for control and test applications. With support for the latest wireless data acquisition devices and drivers for 22 third-party wireless sensors, it simplifies programming of distributed measurement systems with a single software platform. New 3-D visualization tools help engineers integrate remote measurements with design models to accelerate design validation.

LabVIEW has since evolved into a complete programming environment; anything that we can imagine can probably be implemented in LabVIEW. Recent versions of LabVIEW have added a full suite of tools for doing signal processing, and since soundcard operations are provided, it becomes natural to develop audio signal processing applications in LabVIEW.

B. SYSTEM BLOCK DIAGRAM

VI implementation is done using LabVIEW 8.6 version. Advanced signal processing toolkit is used for this purpose. Here Wavelet analysis tools and Time series analysis tools are used for separating HS from LS recordings.

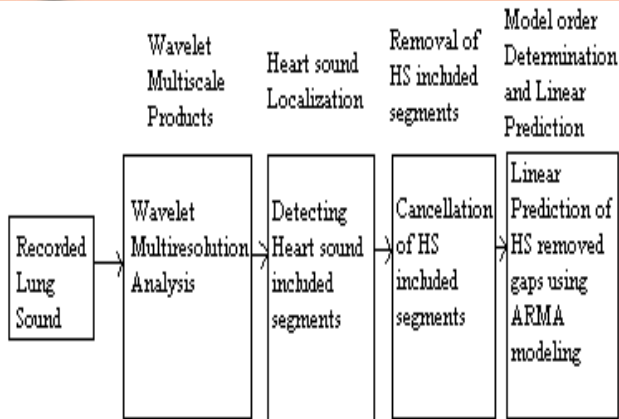

Fig.3. System Block diagram

The block diagram in fig3 shows that main idea of removing or separating heart sound from lung sound by applying the Discrete Wavelet Transform (DWT) to the original LS record and locate HS segments automatically and accurately using multi-scale products, removing those segments from each level of the wavelet coefficients, estimate the removed segments by ARMA modeling of previous data segments. This is the method which is implemented using Labview 8.6 which is discussed below in VI implementation.

C. Data Acquisition

Data used in this study, lung sounds, were acquired with a piezoelectric contact accelerometer (Siemens EMT25C) at the 3rd intercostals space anteriorly on the right upper lung lobe. Lung sounds were digitized at 10240 Hz and 12-bits per sample (National Instruments DAQ) with a custom written software in LabVIEW. Lung sound recordings are used as the input of this VI. These inputs are in .wav format which is read using Sound File Read Simple.VI.

C. Heart Sound Detection

The detection of heart sounds are done by the multiscale product of wavelet approximation coefficients. Multiresolution analysis.VI is used for this purpose, which is an express VI. Three scales were used in wavelet decomposition with the fifth order Symlet wavelet as the mother wavelet. The product of two adjacent decomposition bands presents very interesting properties. Signal and noise have totally different behavior in the wavelet domain this behavior was analyzed using the concept of Lipschitz regularity. The multiplication of the DWT coefficients between the decomposition levels can lead to identification of singularities. In the case of HS detection, the multiscale product of the wavelet coefficients of the original LS record is used to identify the HS segments within the LS signal.

Multiresolution Analysis VI decomposes the signal according to the level we specify and reconstructs the signal from the frequency bands we select. Fig. 2 is the arrangement for finding multiscale product of wavelet approximation coefficients Signals usually contain both low-frequency components and high-frequency components. Low-frequency components vary slowly with time and

require fine frequency resolution but coarse time resolution. High frequency components vary quickly with time and require fine time resolution but coarse frequency resolution.

Multiresolution Analysis (MRA) method is used to analyze a signal that contains both low and high frequency components. Wavelet signal processing is naturally an MRA method because of the dilation process. The DWT is well-suited for multiresolution analysis. The DWT decomposes high-frequency components of a signal with fine time resolution but coarse frequency resolution and decomposes low-frequency components with fine frequency resolution but coarse time resolution. The central frequency and frequency bandwidth of the detail coefficients decrease by half when the decomposition level increases by one. For example, the central frequency and frequency bandwidth of D2 are half that of D1. The approximation at certain resolution contains all of the information about the signal at any coarser resolutions. For example, the frequency band of A2 covers the frequency bands of A3 and D3. DWT-based multiresolution analysis helps to better understand a signal and is useful in feature extraction applications, such as peak detection and edge detection. Multiresolution analysis also removes unwanted components in the signal, such as noise and trend. The approximation at level 1 is the summation of the approximation and detail at level 2. The approximation at level 2 is the summation of the approximation and detail at level 3. As the level increases, lower frequency components will obtain, or large-scale approximation and detail, of the signal. Use the Multiresolution Analysis Express VI to decompose and reconstruct a signal at different levels and with different wavelet types [19].

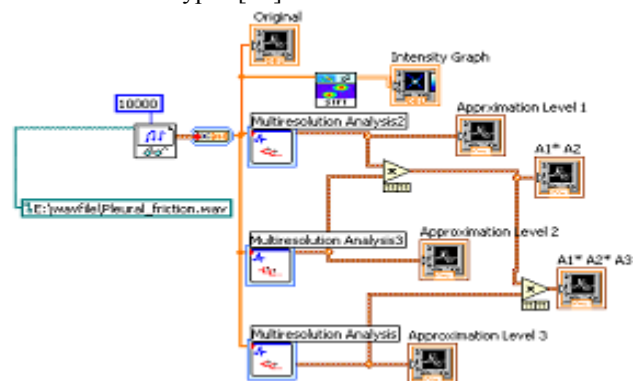

Fig.4. Block diagram of Heart sound detection

D. Heart Sound Cancellation

The DWT of the original LS record was obtained using the Symlet (order 5) wavelet, which is a compactly supported wavelet with least asymmetry and decomposing the signal into 3 levels. Then, the product of the wavelet coefficients was calculated [12]. The cancellation of heart sounds is done by applying a threshold such that,



$$A_i^{Th}(n) = \begin{cases} A_i(n) & P_j(n) < Th \\ 0 & \text{Otherwise} \end{cases}$$

where $Th = (\mu \pm 5\sigma)$

Th(n) are the original and threshold wavelet approximation coefficients at level k, respectively; and Th is the threshold value simply chosen to be above the mean plus or minus 5 times the standard deviation of the portions of original LS free of HS. To extract HS free portions of LS recording, we have to use an express VI named Extract Portion of Signal. Fig. 3 is the block diagram for removing the HS included segments from the original LS including HS. The HS locations were detected accurately and removed from the DWT coefficients of the original LS record.

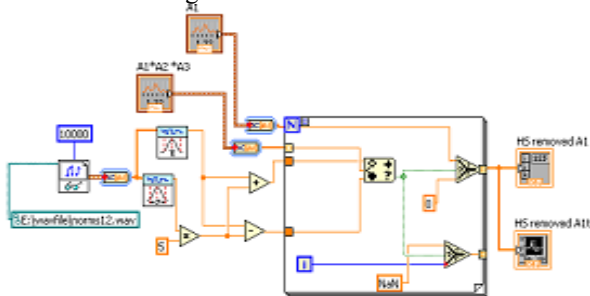

Fig.5. Block diagram for removal of HS.

Fig.6. shows the block diagram for locating the heart sound removed portions.

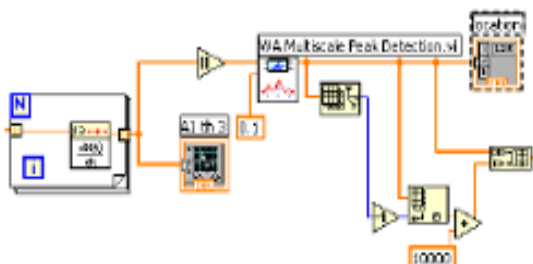

Fig 6. Localization of HS portions.

Next is the grouping of HS located nearby points. Fig 7 shows the block diagram for this purpose. The locations are analyzed and find the portion of original LS to be replaced by the predicted series.

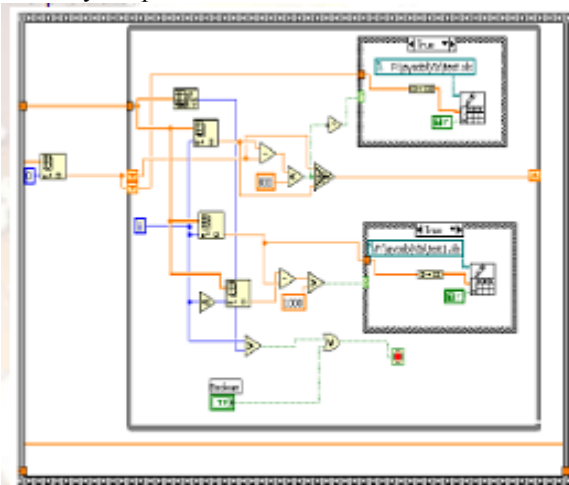

Fig.7. Grouping of nearby HS locations.

E. Modeling and Prediction

The next step was to estimate the removed data by linear prediction, using ARMA models. Here modeling of the LS input and then by using this model, we can predict the values of HS removed portions. TSA ARMA Modeling estimates the autoregressive-moving average (ARMA) model of an input univariate or multivariate (vector) time series according to the method we specify. We can use this polymorphic VI to estimate the ARMA model of waveform, array, vector waveform, and vector array signals. The data type wire to the Xt input determines the polymorphic instance to use. TSA ARMA Prediction predicts the values of an input univariate or multivariate (vector) time series based on the autoregressive-moving average (ARMA) model. We can use this polymorphic VI to perform ARMA prediction on waveform, array, vector waveform, and vector array signals. The data type wire to the Xt input determines the polymorphic instance to use.

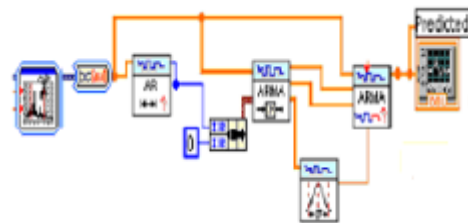
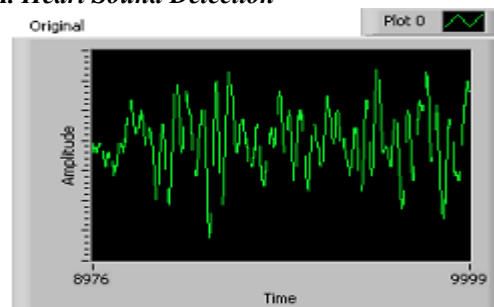

Fig.9. Block diagram of ARMA modeling and prediction.

IV. SIMULATION RESULTS

A. Heart Sound Detection



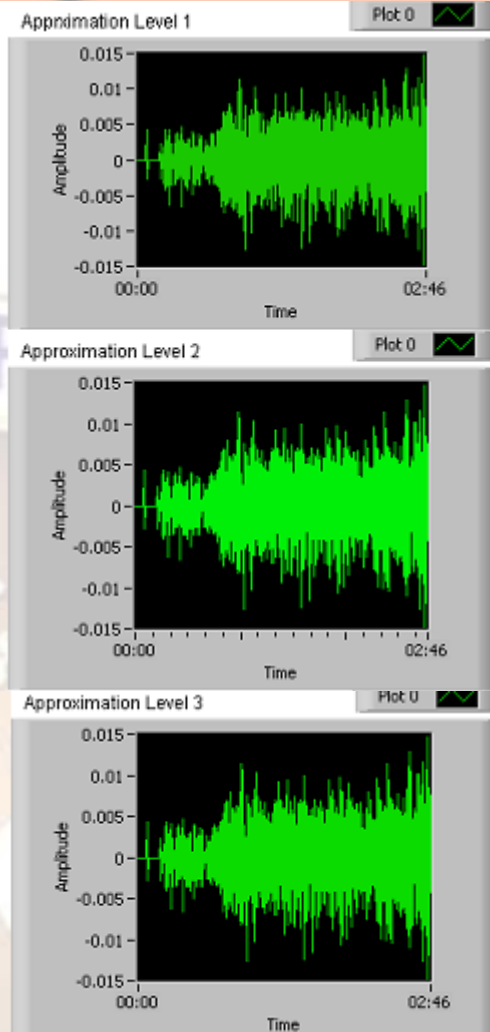

Fig.10. Original LS and the approximation coefficients at levels 1, 2 and 3 respectively.

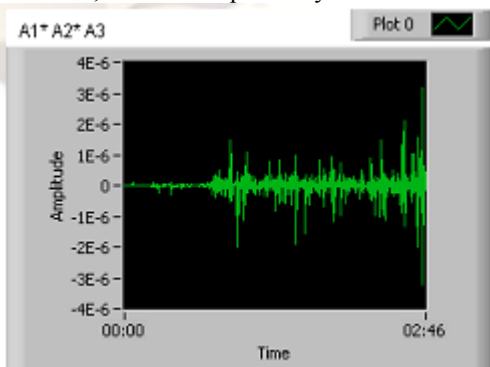

Fig.11. Multiscale product of approximation coefficients of 1

C. Modeling and Prediction

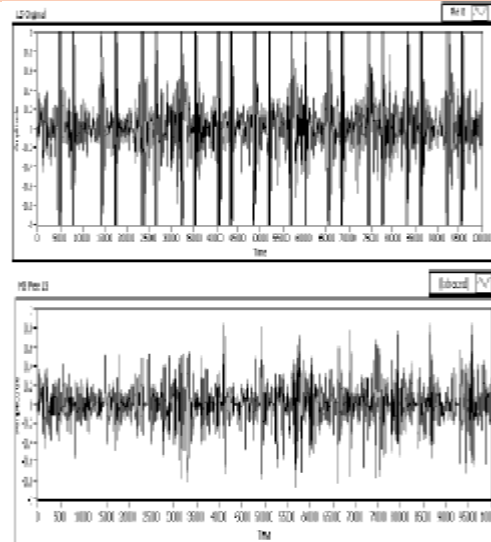

Fig.12. Original LS(top) and HS separated LS(bottom)

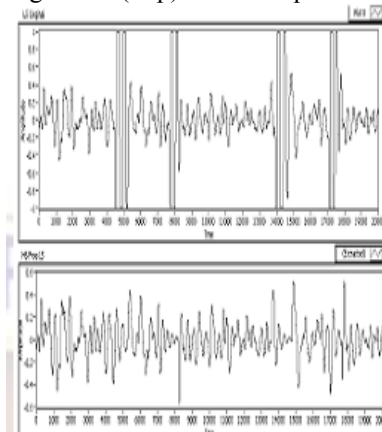

Fig.13. Original LS (top) and HS separated LS (bottom) for 20000 samples

D. Validation of Output

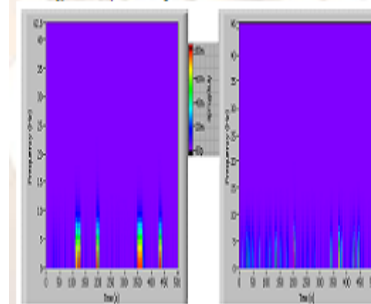

Fig.14. STFT spectrogram of original LS including HS (left) and HS separated LS (right)

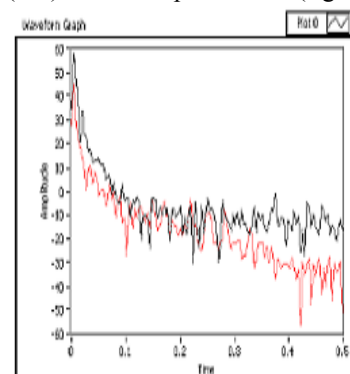

Fig.15. PSD of original LS including HS (black curve) and HS separated LS (red curve).



V. CONCLUSION

This paper presents a novel method for heart sound cancellation from lung sound records. The method uses the multiscale product of the wavelet coefficients of the original signal to detect HS segments. Once the HS segments are identified, the method removes them from the wavelet coefficients at every level and estimates the created gaps by either an AR or MA model. The results were promising in HS removal from LS without hampering the main components of LS. The results were confirmed both quantitatively and qualitatively. To prove the superiority of the presented method to other HS reduction techniques, a larger number of data set is required as well as more evaluating techniques. Once the results are confirmed, the presented method may be used as a part of LS analysis in lung sound assessment in clinical environment.

REFERENCES

- [1] V. Gross, A. Dittmar, T. Penzel, F. Schuttler, P. Von Wichert, "The relationship between normal lung sounds, age and gender," *American Journal of Respiratory and Critical Care Medicine* 2000; 162: 905-909.
- [2] A. Jones, R.D. Jones, K. Kwong, Y. Burns, "Effect of positioning on recorded lung sound intensities in subjects without pulmonary dysfunction," *Physical Therapy* 1999;79:7,682-690.
- [3] Irina Hossain and Zahra Moussavi, "Overview of Heart-noise reduction of Lung sound using Wavelet Transform based filter".
- [4] F. Dalmay, M.T. Antonini, P. Maequet, R. Menier, "Acoustic properties of the normal chest," *European Respiratory Journal* 1995; 8:1761-1769.
- [5] H. Pasterkamp, S.S. Kraman, and G.R. Wodicka, "Respiratory sounds advances beyond the stethoscope," *Amer. J. Respir. Crit Care Med.*, vol. 156, no. 3, Pt 1, pp. 974-987, Sept. 1997.
- [6] H. Pasterkamp, R. Fenton, A. Tal, and V. Chernick, "Interference of cardiovascular sounds with phonopneumography in children," *Am. Rev. Respir. Dis.*, vol. 131, no. 1, pp. 61-64, Jan. 1985.
- [7] Gnitecki J, Moussavi Z., and Pasterkamp H., Recursive Least Squares Adaptive Noise Cancellation Filtering for Heart Sound Reduction in Lung Sounds Recording, *Proc. IEEE Eng. Med. Biol Soci. (EMBS)*, pp. 2416-19, Cancun, Mexico, Sept. 2003.
- [8] Hossain I. and Moussavi Z., An Overview of Heart-Noise Reduction of Lung Sound using Wavelet Transform Based Filter, *Proc. IEEE Eng. Med. Biol Soci. (EMBS)*, pp. 458-61, Cancun, Mexico, Sept. 2003
- [9] Reiser Si. The medical influence of the stethoscope. *Sci Am* 1979: 240:148-56.
- [10] S. Mallat and S. Zhong, "Characterization of signals from multiscale edges," *IEEE Trans. Pattern Anal. Mach. Intell.*, vol.14, no. 7, pp. 710-732, Jul. 1992.
- [11] M. T. Pourazad, Z. Moussavi, G. Thomas, "Heart sound cancellation from lung sound recordings using time-frequency filtering," *International Federation for Medical and Biological Engineering 2006, Med Biol Eng Comput* (2006) 44: 216-225.
- [12] T E Ayoob Khan, Dr. P Vijayakumar "Separating Heart Sound from Lung Sound using LabVIEW".
- [13] N. Gavriely, Y. Palti and G. Alroy, "Spectral characteristics of normal breath sounds," *J. Appl. Physiol.*, vol:50, pp. 307- 314, 1981.
- [14] <http://www.ni.com>



Assistant Professor Mr. Siblu Thomas, received MCA from Sikkim Manipal University, Manipal. He is having total teaching experiences of 12 years. His area of interest is .net technologies. He has published paper in 1 international journal and attended 1 international conference.



Nishi Shahnaj Haider obtained her Bachelors Degree BE (Hons.) in Electronics and Instrumentation, in 2009 and presently doing MTech in Instrumentation and Control from Bhilai Institute of Technology, Durg, India. She is currently with Bhilai Institute of Technology, Raipur, Chhattisgarh, India as Assistant Professor in Applied Electronics and Instrumentation Engineering Department. She had 3 years of teaching experience. She published one paper in International Journal and attended one International conference. Her areas of interest are LIC and its applications, microcontroller and instrumentation technologies.
